

LED Dome lights & Signal Lights - Model 412

PRODUCT INFORMATION

Description	12-48V Clear LED Dome Light with 7" Bare Leads & Switch, No Timer
Height	57.15 mm / 2.25 in
Width	165.10 mm / 6.5 in
Depth	27.69 mm / 1.09 in
Shape	Rectangular
Outer Lens Material	Polycarbonate
Outer Lens Color	Clear
Housing Material	Polycarbonate
Housing Color	Black
Mounting Hardware Description	(x2) M4-0.7 x 16 Mounting Bolts
Mounting Type	Low Profile Mount
Minimum Operating Temperature	-40 °C / -40 °F
Maximum Operating Temperature	65 °C / 149 °F
Connector or Wiring	7" Bare Leads
Product Weight	0.33 lbs / 0.15 kgs
Shipping Weight	5.40 lbs / 2.45 kgs



PRODUCT DIMENSIONS

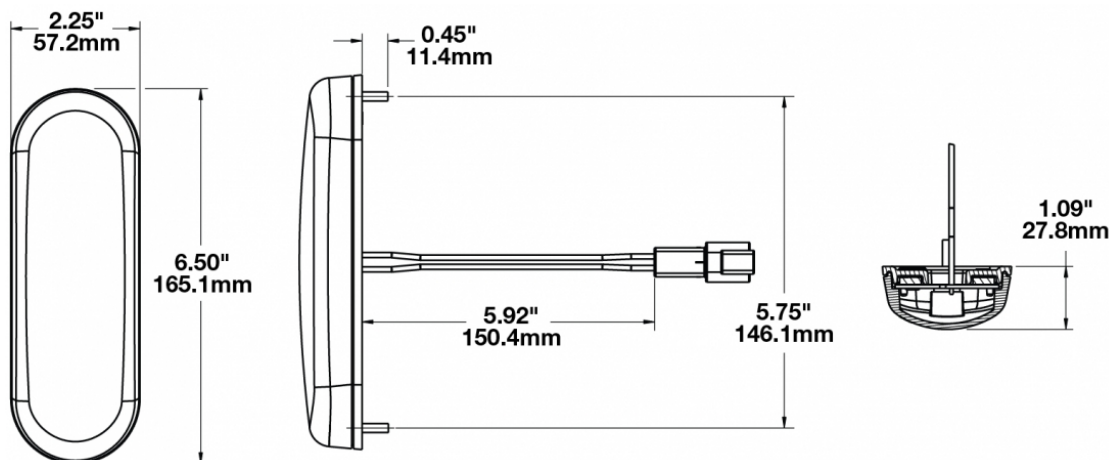

Print date: 2024-08-11

© 2024 J.W. Speaker Corporation • Germantown, WI U.S.A.
www.jwspeaker.com • speaker@jwspeaker.com • 262.251.6660

LED Dome lights & Signal Lights - Model 412

ELECTRICAL SPECIFICATIONS

Input Voltage	12-48V DC
Red Wire	Positive
Black Wire	Negative
Current Draw	0.10A to 0.13A @ 12V DC 0.055A to 0.08A @ 24V DC 0.045A to 0.07A @ 36V DC 0.045A to 0.07A @ 48V DC

REGULATORY STANDARDS COMPLIANCE



Buy America Standards
IEC IP67

Eco Friendly
UL Recognized

PHOTOMETRIC SPECIFICATIONS

Nominal LED Color Temperature	5000 K
Beam Pattern(s)	Interior - Dome Light

APPLICATIONS

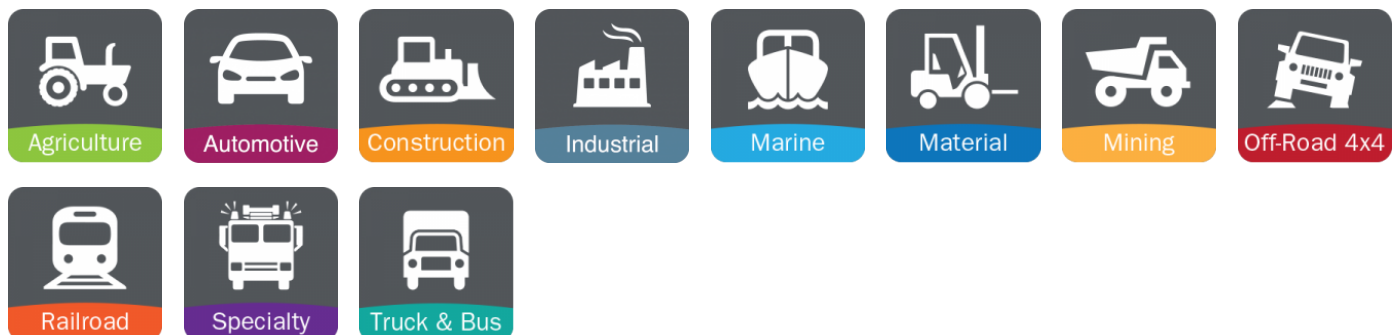

Print date: 2024-08-11

© 2024 J.W. Speaker Corporation • Germantown, WI U.S.A.
www.jwspeaker.com • speaker@jwspeaker.com • 262.251.6660

J.W. SPEAKER
Engineered. Lighting. Solutions.

LED Dome lights & Signal Lights - Model 412

PRODUCT WARNINGS

For California residents:

⚠ **WARNING:** Cancer and reproductive harm - www.P65Warnings.ca.gov.

⚠ **AVERTISSEMENT:** Cancer et effet nocif sur la reproduction - www.P65Warnings.ca.gov.

RELATED PRODUCTS



Part Number
0343121

12-48V ECE LED Front
Position & Front Turn
Signal Light



Part Number
0442511

12-48V Clear LED
Dome Light with 7"
Bare Leads, No Switch,
No Timer



Part Number
0443301

12-48V Clear LED
Dome Light with
Deutsch Connector,
Switch & 60 Minute
Timer